

Impedance Control: An Approach to Manipulation:

Part I—Theory

Neville Hogan

Associate Professor,
Department of Mechanical Engineering
and Laboratory for Manufacturing
and Productivity,
Massachusetts Institute of Technology,
Cambridge, Mass. 02139

Manipulation fundamentally requires the manipulator to be mechanically coupled to the object being manipulated; the manipulator may not be treated as an isolated system. This three-part paper presents an approach to the control of dynamic interaction between a manipulator and its environment. In Part I this approach is developed by considering the mechanics of interaction between physical systems. Control of position or force alone is inadequate; control of dynamic behavior is also required. It is shown that as manipulation is a fundamentally nonlinear problem, the distinction between impedance and admittance is essential, and given the environment contains inertial objects, the manipulator must be an impedance. A generalization of a Norton equivalent network is defined for a broad class of nonlinear manipulators which separates the control of motion from the control of impedance while preserving the superposition properties of the Norton network. It is shown that components of the manipulator impedance may be combined by superposition even when they are nonlinear.

Introduction

Understanding movement and manipulation and how they may best be controlled is a basic endeavour in several different fields. Understanding the strategies adopted by the central nervous system in the control of movement is one of the fundamental problems of neurophysiology; development of artificial limbs to rehabilitate people with functional disabilities requires an understanding of both how the human normally controls and commands movement and how this may best be implemented in a prosthesis or an orthosis; and the use of robots for industrial automation has focused attention on the problems of manipulation by machine.

The work presented here is an attempt to define a unified and general approach to the control of manipulation. The approach developed encompasses and includes the simple positioning or transporting tasks typically performed by robots and/or prostheses. It also builds on this capability, extending it to facilitate the application of robots and/or prostheses to tasks involving static and dynamic interactions between the manipulator and its environment. It will be shown (in Parts II and III) that the approach can lead to a simplification of some problems in manipulator control.

By any reasonable definition, manipulation fundamentally requires mechanical interaction with the object(s) being manipulated, and a useful classification of manipulatory tasks is by the magnitude of the mechanical work exchanged between the manipulator and its environment. In some cases the interaction forces are negligible, the instantaneous

mechanical work done by the manipulator is negligible ($dW = \mathbf{F} \cdot d\mathbf{X} = 0$) and for control purposes the manipulator may be treated as an isolated system, with its motion (e.g., position, velocity, acceleration) as the controlled variable(s). Generally, applications of industrial robots to date have been based on position control, and some of the more successful applications have been restricted to this case; examples are spray-painting and welding [28].

In other situations the manipulator encounters constraints in its environment and the interaction forces are not negligible. Although the manipulator is kinematically coupled to its environment, dynamic interaction is still absent. Along the tangent to a pure (i.e., frictionless) kinematic constraint the interaction forces are zero ($\mathbf{F} = 0$) whereas along the normal into the surface the motions are zero ($d\mathbf{X} = 0$) and in all directions the instantaneous mechanical work done is again negligible ($dW = \mathbf{F} \cdot d\mathbf{X} = 0$). In this case an appropriate control strategy is a combination of motion control along the tangent and force control along the normal [22]. This approach to manipulator control has been termed "compliance" or "force control" [15], is more correctly called "accommodation" [16], and is the topic of a considerable body of laboratory research, although it has not yet seen widespread industrial application.

The most general case (which includes the previous two as special instances) is that in which the dynamic interaction is neither zero nor negligible ($dW \neq 0$). A large class of manufacturing operations fall into this category: examples include drilling, reaming, routing, counterboring, grinding, bending, chipping, fettling—any task requiring work to be done on the environment. Many activities of daily living to be performed by an amputee using a prosthesis—basically any

Contributed by the Dynamic Systems and Control Division for publication in the JOURNAL OF DYNAMIC SYSTEMS, MEASUREMENT, AND CONTROL. Manuscript received by the Dynamic Systems and Control Division June 1983.

task involving the use of a tool—are also in this category. Because of the dynamic interaction, the manipulator may no longer be treated for control purposes as an isolated system. Strategies directed toward the control of a vector quantity such as position, velocity, or force will be inadequate as they are insufficient to control the mechanical work exchanged between the manipulator and its environment.

A solution to this problem is to modulate and control the dynamic behavior of the manipulator in addition to commanding its position or velocity. If the environment is regarded as a source of “disturbances” to the manipulator, then modulating the “disturbance response” of the manipulator will permit control of dynamic interactions [18]. One way to vary the dynamic behavior of a manipulator would be to vary the parameters and/or structure of a feedback controller [16, 30], but this is not the only way, nor always the best way. Exploiting the intrinsic properties of mechanical hardware can also provide a simple, effective, and reliable way of dealing with mechanical interaction [3, 4, 17, 31]. A unified framework in which to consider the action of both hardware and software in controlling dynamic interaction is desirable. In the following it is developed from some simple and physically reasonable assumptions.

Physical Equivalence

Throughout this paper it will be assumed that the complete controlled system is hierarchically organized: a high-level supervisory system plans movement task and presents a set of commands $\{c\}$ to a lower-level (real-time) controller which operates directly on the manipulator hardware. Seen from the perspective of the high-level supervisor the control is effectively open-loop. The high-level supervisor, while it may have access to sensory data, does not use that data in an immediate feedback control mode to modulate its commands to the lower-level controller during an ongoing movement. This arrangement is diagrammed in Fig. 1. This organization has been proposed as a general form of control and communication for man/machine systems [26]: it is commonly used for robots [2]; and there is some evidence that the mammalian motor control system is similarly organized [5].

The manipulator is some collection of physical structures, sensors, and actuators (hardware) combined with some set of control algorithms (software). A unified framework for considering the action of both hardware and software in the control of dynamic behavior can be obtained by making the reasonable assumption that no controller can make the manipulator appear to the environment as anything other than a physical system. This can be stated as the following postulate:¹

“It is impossible to devise a controller which will cause a physical system to present an apparent behavior to its en-

¹This bears some resemblance to the Turing test of Artificial Intelligence [29].

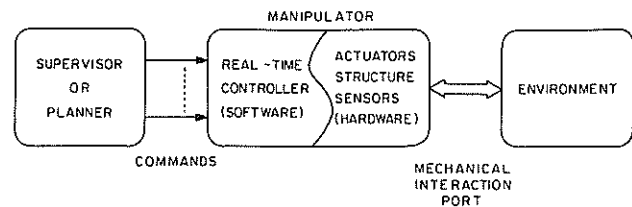

Fig. 1 A schematic diagram of the assumed hierarchical controller structure

vironment which is distinguishable from that of a purely physical system.”

The value of this postulate is that it is now possible to describe the complete controlled system as an equivalent physical system. Any of the several graphical techniques for describing physical systems may now be applied to the complete system, controller plus hardware. The constraints obeyed by physical systems are especially clearly represented by Paynter’s bond graphs [14, 20, 23], and throughout this paper the formalism and terminology of bond graphs will be used.

Causality

Several important constraints on the behavior of physical systems can be identified. Along each degree of freedom, instantaneous power flow between two or more physical systems (e.g., a physical system and its environment) is always definable as the product of two conjugate variables, an effort (e.g., a force, a voltage) and a flow (e.g., a velocity, a current) [20]. An obvious but important physical constraint is that no one system may determine both variables. Along any degree of freedom a manipulator may impress a force on its environment or impose a displacement or velocity on it, but not both.

Seen from the environment along any degree of freedom, physical systems come in only two types: admittances, which accept effort (e.g., force) inputs and yield flow (e.g., motion) outputs; and impedances, which accept flow (e.g., motion) inputs and yield effort (e.g., force) outputs. The concepts of impedance and admittance are familiar to designers of electrical systems as frequency-dependent generalizations of resistance or conductance and are usually regarded as equivalent and interchangeable representations of the same system. For a linear system operating at finite frequencies this is true, but manipulation is fundamentally a nonlinear problem, and for a nonlinear system it is not true; the two representations are in general not interchangeable.

For example, the constitutive equation for a point mass is fundamentally written with velocity as the output variable, defined as a function of momentum; momentum in turn is the integral of the input force. As the constitutive equation for a point mass is invertible the equations may also be written with

Nomenclature

W = mechanical work	Y = admittance	
F, F_1, F_2 = force	Z = impedance	$Zs(\bullet)$ = impedance state equations
X, X_1, X_2 = position	Z_0 = nodic impedance	$Zo(\bullet)$ = impedance output equations
L_1, L_2, L_3 = link lengths	Z_n = nonnodic impedance	y = admittance state variables
$\theta, \theta_1, \theta_2, \theta_3$ = angle	$S(\bullet)$ = static force/displacement relation	$Ys(\bullet)$ = admittance state equations
T_1, T_2, T_3 = torque	X_0 = virtual position	$Yo(\bullet)$ = admittance output equations
$L(\bullet)$ = linkage kinematic equations	V_0 = virtual velocity	V = velocity
$\{c\}$ = modulation by command set	f = flow (velocity)	
Se = effort (force) source	t = time	
Sf = flow (velocity) source	z = impedance state variables	

Fig. 2 (a) associated properly de

force as derivativ between in the s realizabl requires perfectly assumpti although predicted

Howev element r any devi written w tion of in the integri be nonm is that th coenergy exist whi with forc variable.

This in storing e typically vertible r imposed not true.

When kinemati Consider this syste interaction linkage s with this a transfc interactio

For ev {X₁, X₂} invertible

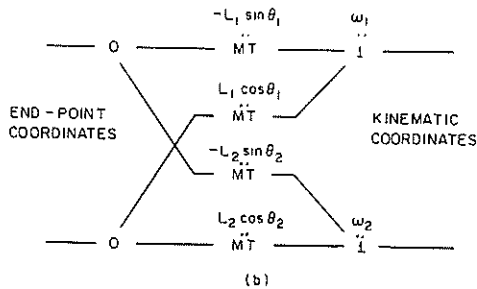
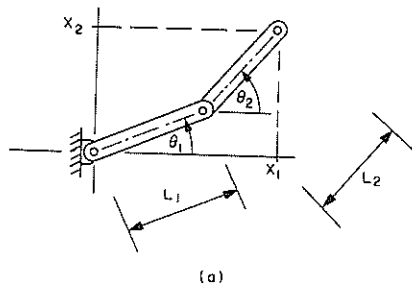

Fig. 2 (a) A planar two-member linkage and (b) a bond-graph of the associated kinematic transformations. Seen from the tip, this system is properly described as an admittance.

force as the output variable, defined as a function of the derivative of the input velocity variable. The only difference between the two representations of this linear element is that in the strictest sense differentiation is not a physically realizable operation as it is the limiting case of process which requires knowledge of the future. However, it is often a perfectly reasonable operation in a model (no worse than the assumption of the existence of lumped-parameter elements) although physically unrealizable infinite power flow may be predicted during transients.

However, the constitutive equation of a nonlinear dynamic element need not be invertible. The constitutive equation for any device which stores elastic energy is fundamentally written with force as the output variable, defined as a function of input displacement; displacement is in turn defined as the integral of input velocity. The constitutive equation may be nonmonotonic or even discontinuous; the only restriction is that the potential energy integral must be definable (the coenergy integral need not be). Real physical elastic devices exist which cannot be described in the derivative causal form with force as the input variable and motion as the output variable.

This inviolable causal constraint is not unique to energy storing elements. The real-world phenomenon of stiction is typically represented by a dissipative element with a noninvertible relation between force and velocity. A velocity may be imposed and a resulting force is defined but the converse is not true.

When more than one degree of freedom is considered, kinematic relations may impose a further causal constraint. Consider the planar linkage shown in Fig. 2(a). Assume that this system may interact with its environment across an interaction port at the tip of the linkage. A bond graph of the linkage showing the two independent power bonds associated with this point is shown in Fig. 2(b). The linkage equations are a transformation between kinematic variables $\{\theta_1, \theta_2\}$ and interaction port variables $\{X_1, X_2\}$:

$$X_1 = L_1 \cos \theta_1 + L_2 \cos \theta_2 \quad (1)$$

$$X_2 = L_1 \sin \theta_1 + L_2 \sin \theta_2 \quad (2)$$

For every point in $\{\theta_1, \theta_2\}$ there is a corresponding point in $\{X_1, X_2\}$ but the transformation is, in general, not uniquely invertible and there exists a two-dimensional infinity of points

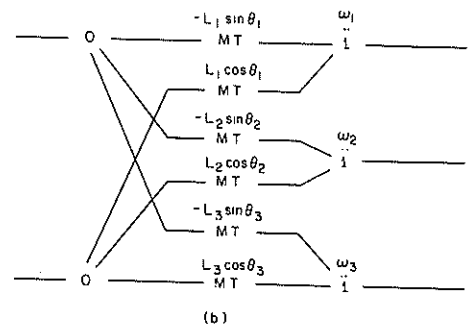
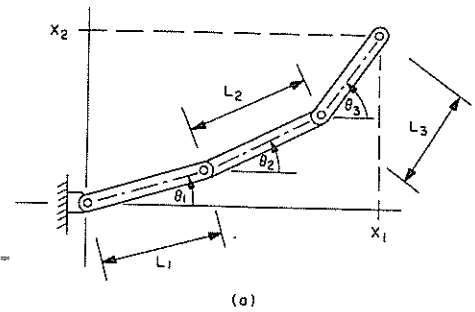

Fig. 3 (a) A planar three-member linkage and (b) a bond-graph of the associated kinematic transformations. Seen from the tip this system is properly described as an admittance.

in $\{X_1, X_2\}$ for which no point in $\{\theta_1, \theta_2\}$ exists. The latter problem could be eliminated by suitably restricting the range of points in $\{X_1, X_2\}$, and given a knowledge of the current joint angles the angular displacement corresponding to an end-point displacement could be uniquely defined.

However, consider the planar linkage shown in Fig. 3(a) and a corresponding bond graph shown in Fig. 3(b). The kinematic transformation equations are:

$$X_1 = L_1 \cos \theta_1 + L_2 \cos \theta_2 + L_3 \cos \theta_3 \quad (3)$$

$$X_2 = L_1 \sin \theta_1 + L_2 \sin \theta_2 + L_3 \sin \theta_3 \quad (4)$$

Again, joint angles uniquely define end-point position but the converse is not true; even given a suitably restricted set of points in $\{X_1, X_2\}$ and a knowledge of the current joint angles, the end-point displacement does not provide sufficient information to determine the joint angular displacements.

In contrast, the corresponding transformation from forces applied at the interaction port to the resulting torques applied to the links is always well defined:

$$T_1 = -L_1 \sin \theta_1 F_1 + L_1 \cos \theta_1 F_2 \quad (5)$$

$$T_2 = -L_2 \sin \theta_2 F_1 + L_2 \cos \theta_2 F_2 \quad (6)$$

$$T_3 = -L_3 \sin \theta_3 F_1 + L_3 \cos \theta_3 F_2 \quad (7)$$

In fact, examination of the five-port bond graph of Fig. 3(b) will show that any combination of two efforts (forces or torques) may be impressed. Similarly, for the four-port bond graph of Fig. 2(b) any two efforts may be impressed. The kinematic transformations $\mathbf{X} = \mathbf{L}(\theta)$ (equations (1), (2), (3) and (4)) are in fact part of the junction structure through which the various elements in a physical system interact² and impose a kinematic causal constraint which is related to but distinct from the conditions imposed by zero- and one-

²As an aside, it is the fact that in bond graphs functional relations are represented at graph nodes which makes the equivalence of transformers, gyrators and junctions clear. In contrast, in linear graphs [25] or Mason (signal flow) graphs [27] the junctions are implicit in the graph structure while transformers and gyrators masquerade as elements, and the equivalence is not clear. This is a strong reason for preferring bond-graphs over other methods for graphing physical dynamic systems. Paynter has pointed out some other more important reasons [21].

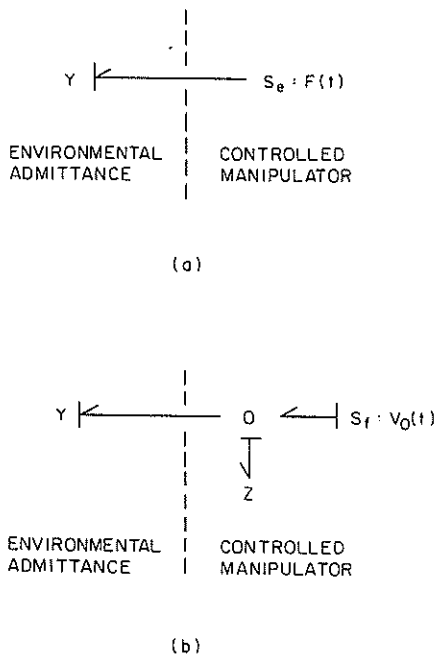

Fig. 4 Bond graph equivalent network representations of (a) pure force control and (b) impedance control

junctions [20]. Any one bond may be causally indifferent but its causality is constrained relative to the others.

The point of this discussion is that the distinction between admittance and impedance is fundamental: Real physical systems exist which can be described in one form and not the other. A spring with a nonmonotonic constitutive equation can only be described as an impedance; seen from an interaction port at its tip, the behavior of a kinematically constrained system such as the linkage of Fig. 3 can only be described as an admittance.

The most important consequence of dynamic interaction between two physical systems is that one must physically complement the other: Along any degree of freedom, if one is an impedance, the other must be an admittance and vice versa. Now, for almost all manipulatory tasks the environment at least contains inertias and/or kinematic constraints, physical systems which accept force inputs and which determine their own motion in response. However, as described above, while a constrained inertial object can always be pushed on, it cannot always be moved; These systems are properly described as admittances. Seen from the manipulator, the world is an admittance.

When a manipulator is mechanically coupled to its environment, to ensure physical compatibility with the environmental admittance, the manipulator should assume the behavior of an impedance. Because the mechanical interaction with the environment will change with different tasks, or even in the course of a single task—the manipulator may be coupled to the environment in one phase and decoupled from it in another—the behavior of the manipulator should be adaptable. Thus the controller should be capable of modulating the impedance of the manipulator as appropriate for a particular phase of a task.

Thus a general strategy for controlling a manipulator is to control its motion (as in conventional robot control) and in addition give it a "disturbance response" for deviations from that motion which has the form of an impedance. The dynamic interaction between manipulator and environment may then be modulated, regulated, and controlled by changing that impedance, and hence the approach described in this paper has been termed "impedance control" [1, 6-11].

Impedance Control, Force Control, and Compliance

If the environment as an admittance, then the manipulator must always impress a force on the environment. It might then be concluded that what is required in general is the control of a vector of interaction forces. Because the controlled manipulator corresponds to some equivalent physical system, it may be represented by a network of physical system elements such as a bond graph. An equivalent physical network representing *pure* force control along a single degree of freedom is shown in Fig. 4(a). In this graph the force commands from the high-level supervisor to the low-level controller are represented by an effort source, an ideal element which may impose any time-history of force on the rest of the system independent of its motion.

If it is assumed that at a minimum the manipulator should be capable of stably positioning a simple mass it can be seen that this network is an incomplete description of the necessary controller action: Stable positioning requires at a minimum a static relation between force and position; some spring-like element must be included in the equivalent physical network. The controller must specify a vector quantity such as the desired position, but it must also specify a quantity which is fundamentally different: a relationship, an impedance, which has properties similar to those of a second-rank, twice-covariant tensor; it operates on a contravariant vector of deviations from the desired position to produce a covariant vector of interface forces. In fact, linearized components of the impedance such as the stiffness and the viscosity are second-rank twice covariant tensors.

The simplest equivalent physical network representing impedance control is shown in Fig. 4(b). The position commanded by the high-level supervisor is represented by a flow source,³ an ideal element which may impose any time history of velocity on the rest of the system. To prevent causal conflict between this element and the environmental admittance (which must experience an impressed effort) a zero-junction⁴ is interposed between the two. The impedance coupled to this zero-junction represents the relation between force and motion commanded by the supervisor and includes both the static force/displacement relation plus the possible dynamic terms required to ensure controlled dynamic behavior.

The problems of controlling the mechanical interaction between a manipulator and its environment have been addressed by many researchers. The inadequacies of conventional position control are widely recognized and the alternatives are typically referred to as "force control," "compliance," "compliant motion control" or "fine motion control" [12, 13, 15, 19, 22, 30]. As discussed above, pure force control is also inadequate; however, the term is applied loosely to control strategies using force feedback in combination with other feedback variables such as position and/or velocity. The concept of tuning stiffness, damping, and other aspects of the dynamic behavior of a manipulator has been explored by several researchers [18, 19, 24, 30], and the two possible causal forms of manipulator behavior were discussed by Nevins and Whitney [16]. However, they argued that when the manipulator was in contact with the environment the appropriate strategy was to "command a position or velocity and look at feedback forces" and this approach was used in their subsequent work [30] and that of many other researchers [12, 13, 19]. This is equivalent to

³In keeping with standard bond graph practice, the imposition of either a position or a velocity is represented by a flow source. The assumption is that the position is uniquely defined by the integral of the velocity. Either the velocity is known for the infinite past, or an initial position and the subsequent time-history of velocity are known [20].

⁴A zero-junction means that all systems connected to it experience the same effort whereas their flows sum to zero.

Fig. 5 A minimum n including bc

giving the bodies an described reasonably above, be inertial ob admittance This distrib important generality

Generaliz

Is the s by the equ multi-axis of the con flow sour impedance The separ: componer properties nonlinear assumption

Figure impedance invariance change in Consider The nodic maintaine interactio written ir than an a between ponents, position Examples finite wor compone: the mani clude bo controler practical positions control a these pos paper is v

Equiva complem engineers under ste usual) so underlying

⁵A one-j flow where:

liance

manipulator
It might
eral is the
e the con-
nt physical
cal system
ysical nete-
degree of
orce com-
-level con-
al element
rest of the

tor should
an be seen
necessary
minimum a
spring-like
l network.
ch as the
y which is
nce, which
nk, twice-
vector of
covariant
ponents of
osity are

presenting
tion com-
by a flow
ne history
ent causal
mental ad-
rt) a zero-
impedance
n between
e includes
e possible
dynamic

interaction
been ad-
of con-
and the
control,"
ne motion
ove, pure
is applied
: in com-
position
damping,
manipulator
, 30], and
avior were
y argued
n the en-
nmand a
and this
nd that of
ivalent to

of either a
n is that the
ie velocity is
quent time-

ce the same

ie ASME

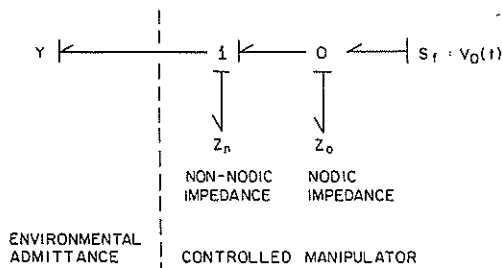

Fig. 5 A bond graph equivalent network representation of the minimum necessary structure of an impedance-controlled machine including both nodic (Z_0) and non-nodic (Z_n) impedance

giving the manipulator the behavior of an admittance, embodies an implicit assumption that the environment can be described as an impedance, and the approach might reasonably be termed "admittance control." As described above, because of the nature of kinematically constrained inertial objects, the environment is properly described as an admittance and the manipulator should be an impedance. This distinction is not merely one of terminology, but has important consequences, as discussed further below. First, the generality of impedance control is considered.

Generalized Equivalent Networks

Is the simple single-axis impedance controller represented by the equivalent network of Fig. 4(b) applicable to a general multi-axis manipulator? That network depicts the separation of the controller action into two distinct components, one (the flow source) representing the control of motion, the other (the impedance) representing the control of dynamic interaction. The separation of the controller action into a (vector) motion component and a impedance component (which has the properties of a tensor) can be achieved for a general class of nonlinear controlled manipulators but some further assumptions about the controller structure are required.

Figure 4(b) represents only the nodic component of the impedance seen at the interaction port. Nodicity refers to the invariance of the constitutive equation of an element under a change in the reference value (origin) of its argument. Consider again the static relation between force and position: The nodic component of this relation is the part which may be maintained invariant under a change in the coordinates of the interaction port, i.e., when the manipulator moves. It may be written in terms of a displacement of the end-point rather than an absolute position of the end-point. A general relation between force and position may include non-nodic components, relations which may only be written in terms of the position of the end point in some fixed reference frame. Examples of the latter include the constraints imposed by the finite workspace of a nonmobile manipulator. The non-nodic components should be coupled to a one-junction⁵ shared by the manipulator and the environmental admittance. To include both of these components the minimum necessary controller structure is as shown in Fig. 5. However, in most practical situations the primary concern is to be able to specify positions of the workpiece in the workspace and to be able to control aspects of the behavior of the workpiece at any of these positions. Accordingly, the immediate concern of this paper is with the nodic component of the impedance.

Equivalent networks of the Norton form (Fig. 4(b)) or the complementary Thevenin form are familiar to systems engineers, but they are normally applied only to linear systems under steady-state conditions [25]. With nonlinear systems (as usual) some difficulties are encountered. The basic concept underlying both Thevenin and Norton equivalent networks is

⁵A one-junction means that all systems connected to it experience the same flow whereas their efforts sum to zero.

the separation of unilateral power transmission effects from bilateral dynamic interaction effects. For any general physical system the equivalent source term seen at an interaction port is defined as that required to ensure zero power flow across the port. The differential equation relating port variables under conditions of zero net power flow is the impedance or admittance. Note that nonlinearity does not enter into these definitions. Unfortunately, the junction structure (common effort or common flow) and concomitant superposition properties of the Norton and Thevenin equivalent networks is only guaranteed for linear systems. This means that in a nonlinear system the separation of effects is possible, but reassembling the pieces is not necessarily easy.

The superposition properties may be preserved by assuming that the structure of the manipulator controller is such that it is always capable of determining an equilibrium position of an unconstrained inertial object. If the system is not at equilibrium, assume the set of commands (which may in general vary with time) are "frozen" at their current instantaneous values and impose steady-state conditions. The manipulator behavior (assumed to be nodic) is then characterized by a static relation between force and position (modulated by the command set).

$$F = S(X); \{c\} \quad (8)$$

By assumption the manipulator is interacting with an unconstrained inertial object, thus at equilibrium in steady state the interface force is zero. Now assume that zero interface force defines a unique equilibrium position. That is, the class of impedances considered is restricted so that if the gradient of the static force/position relation is nonzero, zero force defines a unique position. As a result the command set always defines an equivalent equilibrium position.

$$X_0 = X_0; \{c\} \quad (9)$$

This is the position with respect to which the input displacements to the nodic impedance are measured. It may be thought of as the position toward which the manipulator is heading⁶ at any point in time. The actual position of the manipulator end-point may, of course, be different and as the commands may change with time, the manipulator need never reach the position X_0 . Consequently, this position need not be restricted to lie within the workspace of the manipulator. It is a convenient fiction and is a summary statement of one consequence of the commands. To keep this distinction clear, X_0 is referred to as a "virtual position" and its time history $X_0(t)$ is referred to as a "virtual trajectory."

By defining the virtual trajectory the behavior of the controlled manipulator has been decomposed into a vector of port variables which may be commanded and a relation between port variables, an impedance, which may also be commanded. The value of this exercise is that by definition the two components may now be reassembled in the simple manner represented by a zero-junction. The superposition properties of the Norton equivalent network have been retained *without restriction to linear systems*.

The behavior of the manipulator may now be written as follows (assuming a state-determined system):

$$V_0 = V_0; \{c\} \quad \text{Virtual Source} \quad (10)$$

$$f = V_0 - V \quad \text{Junction Equations} \quad (11)$$

$$dz/dt = Zs(z, f); \{c\} \quad \text{Nodic Impedance} \quad (12)$$

$$F = Z_0(z, f); \{c\} \quad (13)$$

As before, following standard bond graph convention the imposition of a virtual position or a virtual trajectory has

⁶Or, if the equilibrium point is unstable, away from which it is heading.

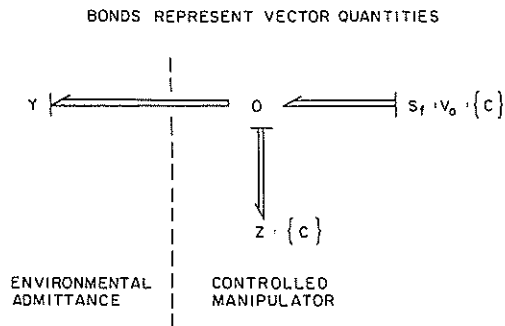

Fig. 6 A bond graph equivalent network representing a multi-axis manipulator with controlled nodic impedance interacting with an admittance-type environment. The bond graph for the manipulator is a generalized Norton equivalent network.

been represented by a flow source. Writing the environmental admittance in general form:

$$dy/dt = Ys(y, F) \quad (14)$$

Admittance

$$V = Yo(y) \quad (15)$$

The two sets of equations may be combined to write the complete system equations in standard (integrable) form:

$$dz/dt = Zs(z, [V_0 \cdot \{c\} - Yo(y)]) \cdot \{c\} \quad (16)$$

$$dy/dt = Ys(y, Zo(z, [V_0 \cdot \{c\} - Yo(y)]) \cdot \{c\}) \quad (17)$$

$$F = Zo(z, [V_0 \cdot \{c\} - Yo(y)]) \cdot \{c\} \quad (18)$$

$$V = Yo(y) \quad (19)$$

The purpose of the foregoing discussion was to demonstrate that a broad and useful class of nonlinear manipulator behaviors may be represented by a simple equivalent network. The only assumptions made were that the manipulator is sufficiently controllable to be able to determine an equilibrium position of an unconstrained inertial object such as a mass, that the port impedance is nodic, and that its static component is such that if its gradient is nonzero then zero force defines a unique position—not a restrictive set of assumptions. Thus a general class of manipulation problems have the same basic structure as Fig. 4(b). The behavior of a multi-axis impedance-controlled manipulator interacting with an admittance-type environment may be represented by the graph shown in Fig. 6, which is a generalization of a Norton equivalent network. Not only does this graph provide a compact representation of manipulation, the parallel with the standard Norton equivalent network is quite complete: The superposition properties of the Norton equivalent network have been preserved.

Superposition of Impedances

The most interesting consequence of the assumptions underlying impedance control is that if the dynamic behavior of the manipulator is dissected into a set of component impedances, these may be reassembled by simple addition *even when the behavior of any or all of the components is nonlinear*. This is a direct consequence of the assumption that the environment is an admittance. That admittance sums the forces applied to it and determines its motion in response, as represented by the one-connection of Fig. 5. The admittance also acts to sum any impedances coupled to it. All of the systems connected to the one-connection associated with the admittance experience the same input velocity; the total force they apply to the admittance is simply the sum of their individual force responses to the motion of the environmental admittance. Linearity of the impedances is not a consideration.

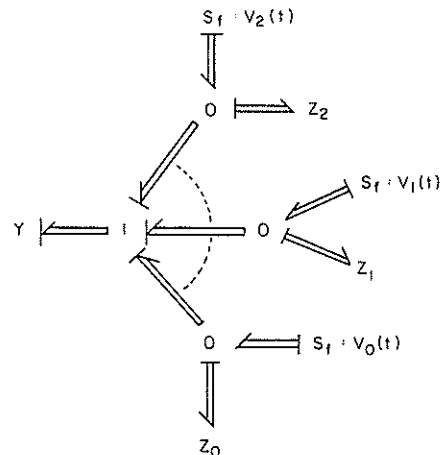

Fig. 7 A bond graph equivalent network representation of the superposition of multiple impedances coupled to an admittance. Each component of the total impedance is represented by a generalized Norton equivalent network. Non-nodic impedances may be included in this system by setting the corresponding virtual flow source to zero.

When the manipulator is decoupled from its environment the terms in the dynamic equations due to the environmental admittance disappear and in principle the manipulator alone need exhibit no inertial behavior. In practice the uncoupled manipulator still has inertia (albeit nonlinear and configuration-dependent). Because of the inevitable inertial dynamics of the isolated manipulator the superposition of impedances holds even when the manipulator is uncoupled from its environment as there is always an admittance to sum forces and impedances.

This simple observation has many important consequences, some of which will be pursued in the subsequent parts of this paper. One which is immediately apparent is that different controller actions aimed at simultaneously satisfying different task requirements may be superimposed. Each task component may be represented by a generalized Norton equivalent network, but referred to a different node (or virtual position) as shown in Fig. 7. Note that any non-nodic component of the manipulator behavior may be included in this equivalent network by associating it with a flow source identically equal to zero and thus the assumption of nodicity made earlier is not restrictive.

Summary

This paper has presented a unified approach to manipulation termed "impedance control." Because by its nature manipulation requires mechanical interaction between systems, the focus of the approach is on the characterization and control of interaction. To understand interaction concepts drawn from bond graph network analysis of dynamic systems are useful, particularly the concept of causality. By assuming that no control algorithm may make a physical system behave like anything other than a physical system the network concepts of bond graphs may be applied to describe the way the controller may modify the behavior of the manipulator. Several simple but fundamental observations may then be made: Command and control of a vector such as position or force is not enough to control dynamic interaction between systems; the controller must also command and control a relation between port variables. In the most common case in which the environment is an admittance (e.g., a mass, possibly kinematically constrained) that relation should be an impedance, a function, possibly nonlinear, dynamic, or even discontinuous, specifying the force produced in response to a motion imposed by the environment. Even more important, if the environment is an admittance, the total impedance coupled to it (due to the manipulator or anything

else) is exp when the c Under a interaction decompose pedance c second-rar may be ex controlled interaction p and imped reassemble structure d that no r linearity w Part II a and applic

Acknowledgment

Portion by: NSF Gr NIHR C The Wh Polaroi The Jo The Ra Americ The TR This supp were per Laborato Acoustics and the L

References

- 1 Andre Implementer of Manufa Book, W. J
- 2 Brady M., (Eds.), 1983.
- 3 Cutko Industrial R
- 4 Drake Automatic. 1977.
- 5 Evaru Eds., Neuru
- 6 Hoga Manipulato 1, San Fran

else) is expressible as a sum of component impedances, even when the components are nonlinear.

Under a set of reasonable and unrestrictive assumptions the interaction port behavior of the manipulator may be decomposed into a vector motion component and an impedance component with some of the characteristics of a second-rank, twice-covariant tensor. The vector component may be expressed as a virtual trajectory towards which the controlled manipulator dynamics are trying to drive the interaction port. Its significance is that it permits the motion and impedance components of the manipulator behavior to be reassembled by superposition as depicted by the junction structure of a generalized Norton equivalent network. Note that no restrictive assumptions of small displacements or linearity were required.

Part II and III of this paper will discuss the implementation and application of impedance control.

Acknowledgments

Portions of the work reported in this paper were supported by:

- NSF Grant No. PFR 7917348
- NIHR Grant No. G00 820 0048, Department of Education
- The Whitaker Health Sciences Fund
- Polaroid Corporation
- The John and Fannie Hertz Foundation
- The Ralph E. Cross Fund
- American Can Company
- The TRW Foundation Faculty Fellowship

This support is gratefully acknowledged. Portions of the work were performed in the Eric P. and Evelyn E. Newman Laboratory for Biomechanics and Human Rehabilitation, the Acoustics, Vibrations and Machine Dynamics Laboratory, and the Laboratory for Manufacturing and Productivity.

References

- 1 Andrews, J. R., and Hogan, N., "Impedance Control as a Framework for Implementing Obstacle Avoidance in a Manipulator," pp. 243-251 in: *Control of Manufacturing Processes and Robotic Systems*, Eds. Hardt, D. E., and Book, W. J., American Society of Mechanical Engineers, New York, 1983.
- 2 Brady, M., Hollerbach, J., Johnson, T., Lozano-Perez, T., and Mason, M., (Eds.), *Robot Motion: Planning and Control*, MIT Press, Cambridge, 1983.
- 3 Cutkosky, M. R., and Wright, P. K., "Position Sensing Wrists for Industrial Manipulators," *Proceedings of the 12th International Symposium on Industrial Robots*, Paris, France, June 1982.
- 4 Drake, S., "Using Compliance in Lieu of Sensory Feedback for Automatic Assembly," Charles Stark Draper Laboratory Report T-657, Sept. 1977.
- 5 Evarts, E. V., Bizzi, E., Burke, R. E., DeLong, M., and Thach, W. T., Eds., *Neurosciences Research Program Bulletin*, Vol. 9, No. 1, 1971.
- 6 Hogan, N., "Mechanical Impedance Control in Assistive Devices and Manipulators," *Proceedings of the Joint Automatic Controls Conference*, Vol. 1, San Francisco, Aug. 1980.

7 Hogan, N., "Impedance Control of a Robotic Manipulator," Presented at the Winter Annual Meeting of the American Society of Mechanical Engineers, Washington, D.C., 1981.

8 Hogan, N., "Programmable Impedance Control of Industrial Manipulators," *Proceedings of the Conference on CAD/CAM in Mechanical Engineering*, MIT, Mar. 1982.

9 Hogan, N., "Mechanical Impedance Control in Assistive Devices and Manipulators," pp. 361-371 in: *Robot Motion: Planning and Control*, Eds. Brady, M., Hollerbach, J., Johnson, T., Lozano-Perez, T., and Mason, M., MIT Press, Cambridge, 1983.

10 Hogan, N., "Adaptive Control of Mechanical Impedance by Coactivation of Antagonist Muscles," in: *IEEE Transactions on Automatic Control*, Vol. AC-29, No. 8, August 1984, pp. 681-690.

11 Hogan, N., and Cotter, S. L., "Cartesian Impedance Control of a Nonlinear Manipulator," pp. 121-128 in: *Robotics Research and Advanced Applications*, ed. Book, W. J., American Society of Mechanical Engineers, New York, 1982.

12 Inoue, H., "Computer-Controlled Bilateral Manipulator," *Bulletin of the Japan Society of Mechanical Engineers*, Vol. 14, No. 69, 1971, pp. 199-207.

13 Ishida, T., "Force Control in Coordination of Manipulator Fine Motions," *Fifth International Conference on Artificial Intelligence*, 1977.

14 Karnopp, D., and Rosenberg, R., *System Dynamics: A Unified Approach*, Wiley, New York, 1975.

15 Mason, M. T., "Compliance and Force Control for Computer-Controlled Manipulators," *IEEE Transactions on Systems, Man, and Cybernetics*, Vol. SMC-11, No. 6, 1981.

16 Nevins, J. L., and Whitney, D. E., "The Force Vector Assembler Concept," *Proceedings of the 1st. CISM IFTOMM Symposium on Theory and Practice of Robots and Manipulators*, Vol. II, 1974, pp. 273-288.

17 Nevins, J. L., and Whitney, D. E., "Computer-Controlled Assembly," *Scientific American*, Vol. 238, No. 2, Feb. 1978, pp. 62-74.

18 Paul, F. W., Gettys, T. K., and Thomas, J. D., "Defining of Iron Castings Using a Robotic Positioned Chipper," in: *Robotics Research and Advanced Applications*, Ed. Book, W. J., American Society of Mechanical Engineers, New York, 1982.

19 Paul, R. P. C., and Shimano, B., "Compliance and Control," *Proceedings of the Joint Automatic Control Conference*, 1976, pp. 694-699.

20 Paynter, H. M., *Analysis and Design of Engineering Systems*, MIT Press, Cambridge, Massachusetts, 1961.

21 Paynter, H. M., "System Graphing Concepts," *Instruments and Control Systems*, July 1970.

22 Raibert, M. H., and Craig, J. J., "Hybrid Position/Force Control of Manipulators," *ASME JOURNAL OF DYNAMIC SYSTEMS, MEASUREMENT AND CONTROL*, Vol. 102, June 1981, pp. 126-133.

23 Rosenberg, R. C., and Karnopp, D. C., *Introduction to Physical System Dynamics*, McGraw-Hill, New York, 1983.

24 Salisbury, J. K., "Active Stiffness Control of a Manipulator in Cartesian Coordinates," IEEE Conference on Decision and Control, New Mexico, 1980.

25 Shearer, J. L., Murphy, A. T., and Richardson, H. H., *Introduction to System Dynamics*, Addison Wesley, Mass., 1967.

26 Sheridan, T. B., and Ferrell, W. R., *Man-Machine Systems: Information, Control, and Decision Models of Human Performance*, MIT Press, Mass., 1974.

27 Takahashi, Y., Rabins, M. J., and Auslander, D. M., *Control and Dynamic Systems*, Addison-Wesley, Mass. 1970.

28 Tanner, W. R., (Ed.) *Industrial Robots. Volume 2: Applications*, Society of Manufacturing Engineers, Mich., 1981.

29 Turing, A. M., "Computing Machinery and Intelligence," *Mind*, Vol. LIX, No. 236, 1950.

30 Whitney, D. E., "Force Feedback Control of Manipulator Fine Motions," *ASME JOURNAL OF DYNAMIC SYSTEMS, MEASUREMENT AND CONTROL*, June 1971, pp. 91-97.

31 Whitney, D. E., and Nevins, J. L., "What is Remote Center Compliance and What Can It Do?," *Proceedings, Ninth ISIR*, Washington, D.C., Mar. 1979.

tion of the
tance. Each
generalized
included in
to zero.

environment
ronmental
ator alone
uncoupled
and conle
le inertial
osition of
uncoupled
nce to sum

sequences,
irts of this
different
g different
ask com-
equivalent
l position)
ent of the
equivalent
ally equal
lier is not

oach to
se by its
1 between
terization
tion con-
dynamic
sality. By
physical
ystem the
describe
r of the
ervations
r such as
teraction
and and
ost com-
e (e.g., a
n should
amic, or
response
ore im-
otal im-
anything